

CATALOGUE

 Jagram

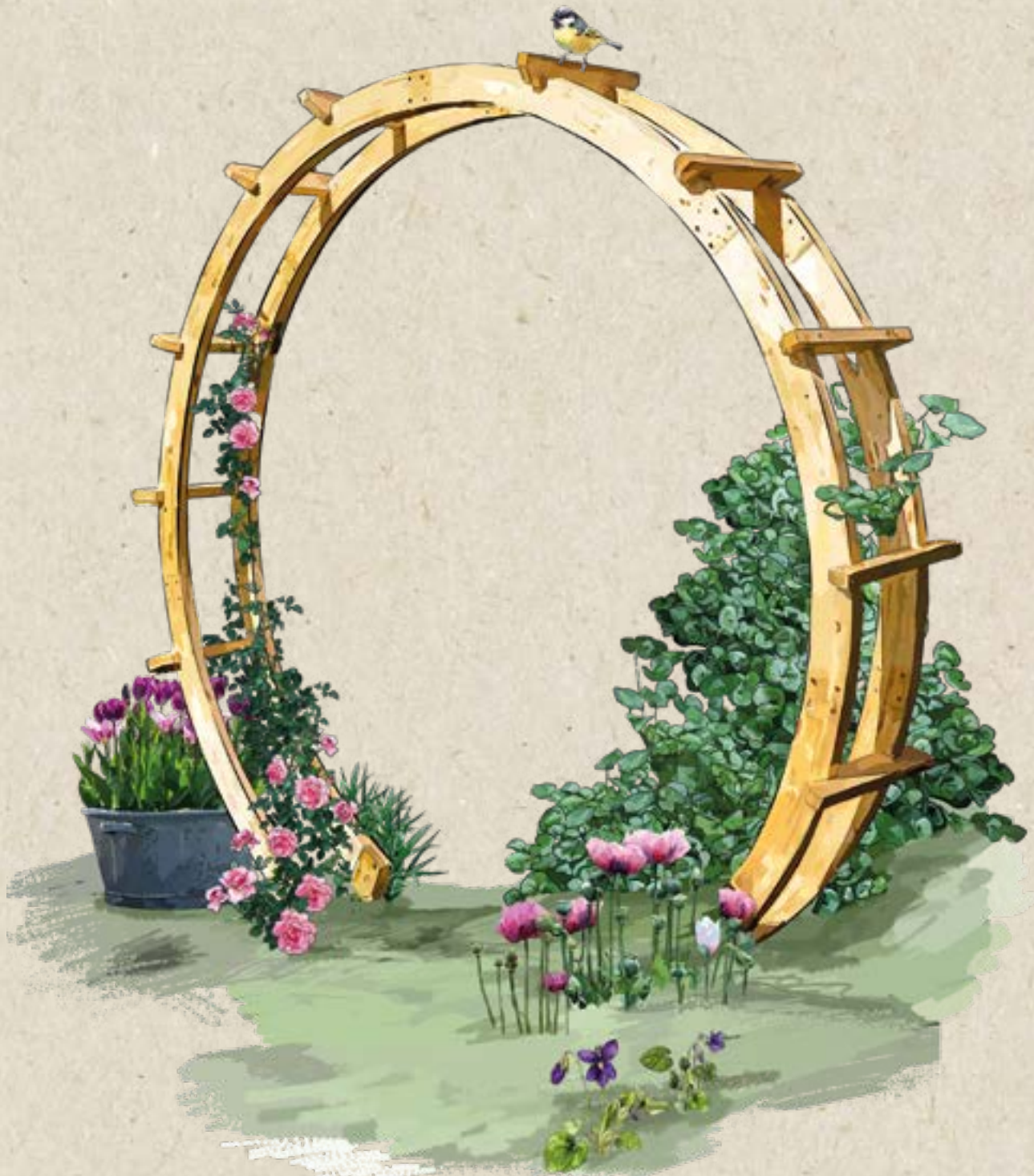

Page Content

- 4**
GLULAM CURVES
- 5**
LEISURE COLLECTION & HAMMOCK STANDS
- 6**
PLANTERS AND OTHER
- 12**
GROW YOUR OWN
- 14**
LUXURY PLANTERS COLLECTION
- 16**
LANDSCAPING TIMBER
- 18**
OUTDOOR LAMPS
- 20**
WOODEN GARDEN TRELLISES



- 32**
FENCING PANELS & GATES
- 43**
ACCESSORIES
- 44**
GARDEN ARBOURS
- 52**
GARDEN ARCHES
- 60**
PAVILIONS
- 62**
CERTIFICATES



Jagram

is a unique company, difficult to compare with any other

For example, we believe that success in business can be combined with family life and the pursuit of passions. We also believe that this can be achieved through a work ethic that benefits everyone, be it customers, business partners or employees (not forgetting of course ingenuity, intelligence and hard work). We recognize that this requires constantly learning and respect for the natural and social environment.

In practice, we honestly strive to supply our customers with best products at best conditions, for employees our attitude means no long working hours, and the chance to enjoy free weekends, while for suppliers it means they are paid on time. The company also fulfills all its obligations, pays its taxes, earmarks a significant budget for further training of its team members, and maintains good, long-term relations with business partners. It also means that the company renounces the now widespread use and importing of goods, materials and raw materials that are harmful to the environment and people, despite the potential profitability of such activities.

Quality & craftsmanship

We are garden wood specialists with over 30 years of professional experience; we love working in wood and creating beautiful, functional and durable products. We are proud to have earned • ISO • FSC® • PEFC • ITB certificates and supply our customers with products of the highest quality.



Rest assured you have a 10yr guarantee against rot with all of our products.*



Your product will never need treating. No further maintenance required.



Made from wood sourced from responsible forestry. „Look for FSC® certified products“

All Jagram products have been designed and manufactured to the highest standards. The entire range is manufactured using european timber from responsibly managed forests. FSC® certification available on request. Visit www.jagram.co.uk for more information

*applies to products with no contact with the ground, valid in EU and UK

All sizes shown in the catalogue are approximate.

Glulam Curves



ecocurves
Bespoke Timber Arches

Jagram is one of Europe's leading manufacturers of glued laminated timber curves. In the last 30 years we have tested most of the world's leading glue, machinery and tool brands, adding our own patented solutions to create a technologically unique production process - our factory computers and machines will turn timber laths into laminated curves of the most elaborate shapes in just 40 minutes. If you are looking for a bespoke product - we are the best choice there is.

Imperia Chair
96100



Leisure collection

To create our loungers collection we invited the best designers and timber engineers to focus on ergonomics as well as the visual effect. As a result it combines luxury and comfort to enhance any standard décor, lending it an exclusive, unique appearance. They are also featuring quality, weatherproof, European made, shape adjusted cushions.

www.jagramleisure.com

Hammock Stands

Our hammock stands are recognized by leading hammock distributors around the world for their high quality, unique design and ecological European materials used for their production. The stands' maximum permissible load ranges from 120 to 200 kg.

www.jagramleisure.com

Kite Lounger
96090



Planters

Planters are the perfect products to create an unforgettable space in your garden. Plant some flowers in the pots and enjoy the view. This way of arranging your garden is also perfect for people who get bored easily or just enjoy changing things up. The planters can be moved easily without damaging the roots of the plants. If you choose a planter with trellis, another advantage is the possibility to shield your garden from the neighbours – the attached trellis are perfect for climbing plants to ensure privacy.

Wooden products combine perfectly with the greenery and they don't distract the eyes from the beauty of the plants, merely complementing them.



Oslo Planter

Larch Planters collection



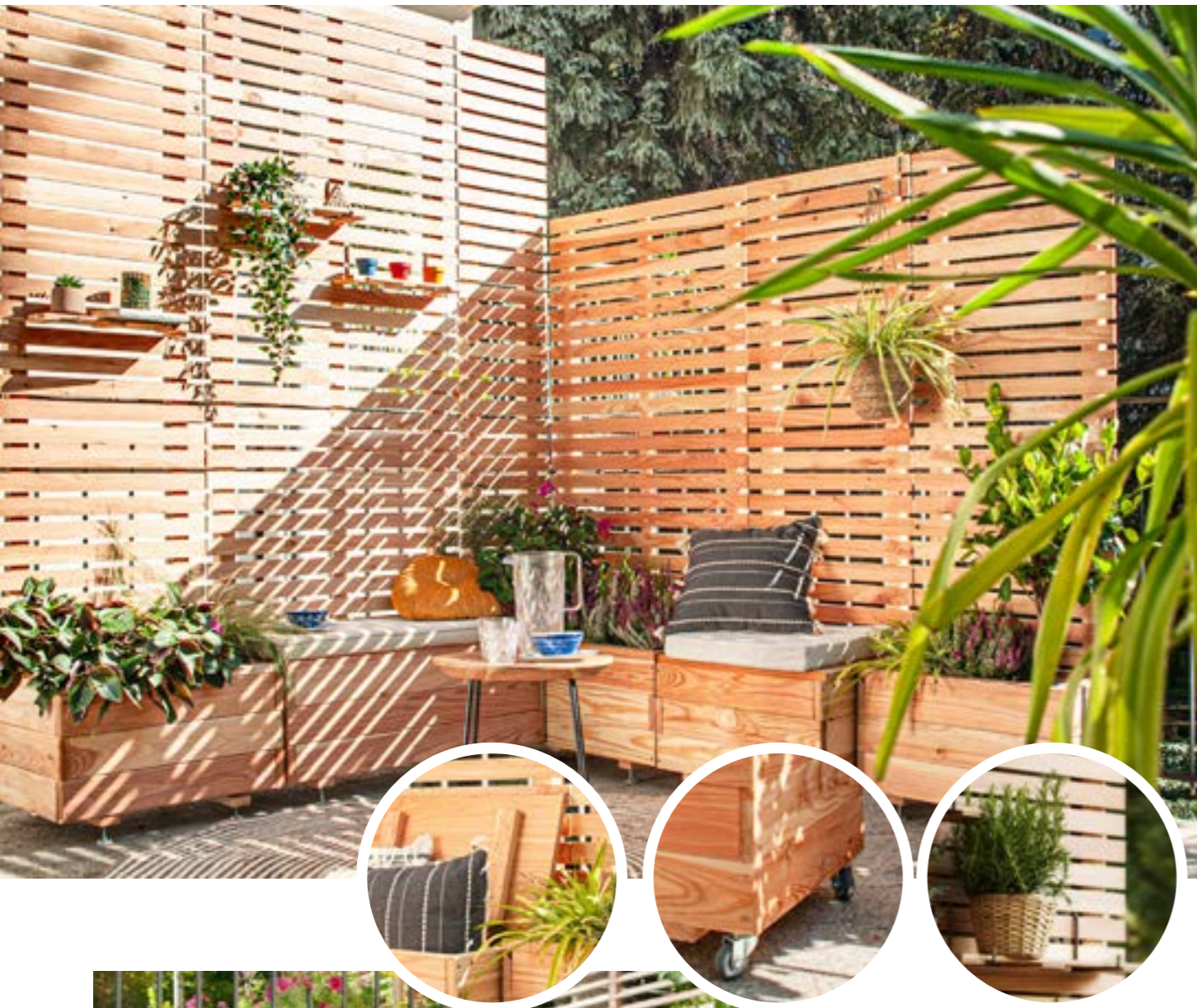

LARCH RECTANGULAR PLANTER

- 050600M 34 x 25 x 39
- 050601M 34 x 25 x 59
- 050602M 34 x 25 x 89
- 050606M 34 x 39 x 39
- 050607M 34 x 39 x 59
- 050608M 34 x 39 x 89

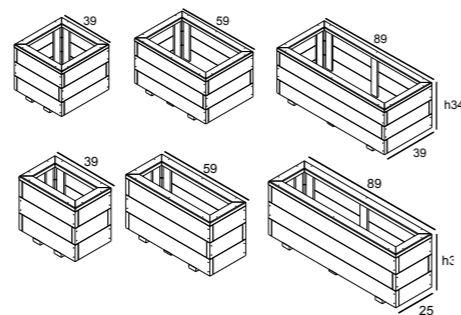

An excellent quality planter with trellis, ideal as a freestanding support for climbing plants or as part of a dividing wall on a patio or in a garden. The beautiful, modern design matches all products from the Larix collection. Smooth finish in amber color of natural larch.

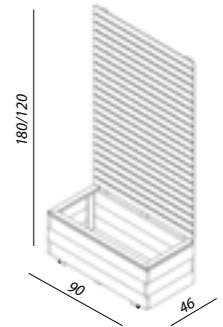

- 052150M 180 x 90 x 46
- 052151M 120 x 90 x 46
- 052152M 180 x 60 x 46
- 052153M 120 x 60 x 46

PIANO - PLANTER WITH TRELLIS

- large planting area ideal for climbing and other deep root plants
- made of slow-grown larch wood resistant to damage
- exceptional outdoor natural durability without the need for preservatives
- convenient place to hang garden tools or work gloves
- shelves, bench, quality castors, height-adjustable feet are optional and available on request.

This multifunctional patio bench of exceptional quality provides at the same time a seating area, storage for tools and cushions, and shelves for potted flowers. An ideal place to store garden tools and cushions. The beautiful, modern design matches all products from the Larix collection. Combined with the Piano trellis, it makes an attractive patio dividing wall. Smooth finish in amber-colored natural larch.

RENE - PATIO BENCH WITH TRELLIS AND STORAGE BOX

- large storage space
- slow-grown larch wood resistant to damage
- exceptional natural durability without the need for preservatives
- shelves, cushion, quality castors, height-adjustable feet are optional and available on request

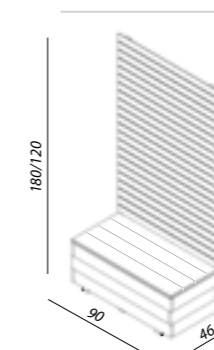

- 052148M 180 x 90 x 46
- 052149M 120 x 90 x 46

Decoration and plants not included



Tanalised Planters collection

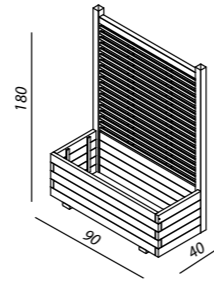

052096 180 x 90 x 40

OSLO PLANTER

Contemporary design, beautiful, pressure treated wooden rectangular planter with venetian trellis. Perfect support for your plants in the garden, on patio or balcony.

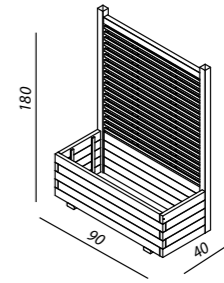

052097 180 x 90 x 40

MJOSA PLANTER

- pressure treated
- wide slats
- more privacy

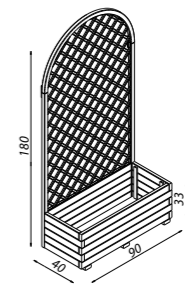

052111 180 x 90 x 40

BERMUDA PLANTER

- easily assembled
- flat packed
- sturdy construction

Luxury Planters collection

- eco-friendly products
- variety of colors
- smart packages

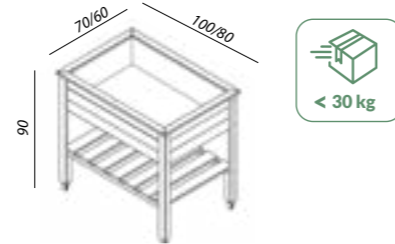

052054 90 x 80 x 60
052039 90 x 100 x 70

PROVENCE PLANTER

- plastic waterproof insert
- end wheels included

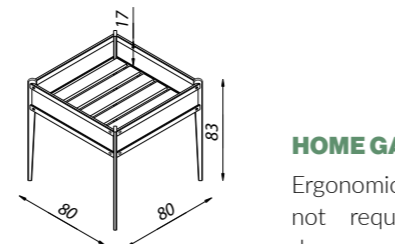
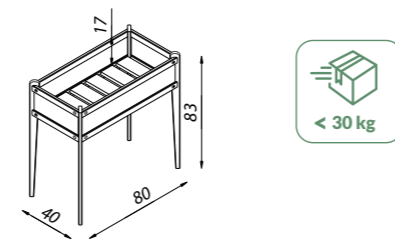

052076 83 x 80 x 80
052078 83 x 40 x 80

HOME GARDEN

Ergonomic height does not require bending down, crops are high thanks to the irrigation valve mounted in heavy duty liner.

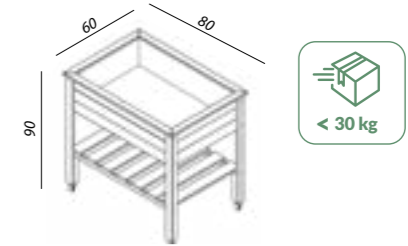

052037 80 x 60 x 90

NORMANDIE PLANTER

- plastic waterproof insert
- end wheels included

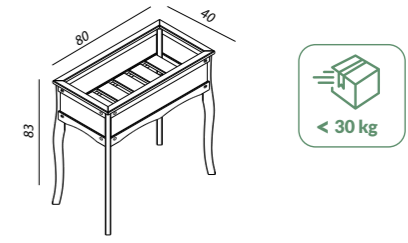

052079 83 x 80 x 40

HOME GARDEN LOUISE

Ergonomic height does not require bending down, crops are high thanks to the irrigation valve mounted in heavy duty liner.

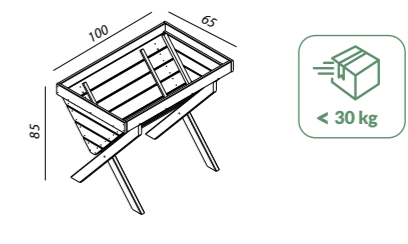

052122 85 x 100 x 65

LAVENDER PLANTER

- deep root veg planter

Grow Your Own and other

When the season for new vegetables arrives, the temptation to add them to sandwiches, whip up salads, or simply snack on them between meals is immense. However, is what we consider healthy truly so? Did the plants not grow near a busy road? Was their growth not hastened with a handful of artificial fertilizer? If such questions nag at you not just in early spring but throughout the entire growing season, we have a solution for you. Eating vegetables grown by yourself provides assurance about their origins. We've curated a whole line of products called "Grow Your Own". Everyone will find in it wooden planters and raised beds tailored to their needs—those suitable for placing in the garden and those that will fit even on a modest balcony or near a window.

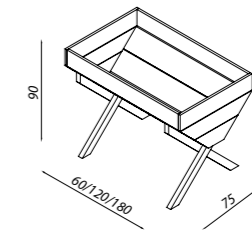

052050 90 x 60 x 75
 052051 90 x 120 x 75
 052052 90 x 180 x 75

RAISED VEGETABLE BED

- planed, smooth surface
- flat packed
- easy to assemble

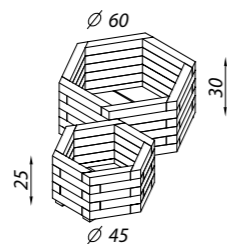

050410 25 x 45
 050411 30 x 60

ROYAL HEXAGONAL PLANTER

- massive planters in 45 x 40 mm sections
- planter ready-assembled

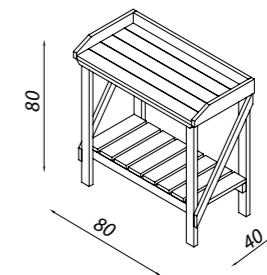

052034 80 x 80 x 40

POTTING BENCH

- with practical worktop and useful shelf
- easy to assemble

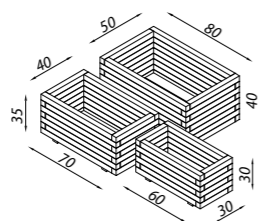

050405 30 x 60 x 30
 050461 35 x 70 x 40
 050462 40 x 80 x 50

ROYAL RECTANGULAR PLANTER

- massive planters in 45 x 40 mm sections
- planter ready-assembled

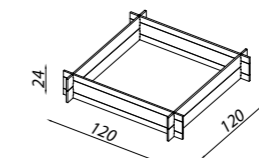

010870 24 x 120 x 120

ECONOMY VEGGIEBED

- rough sawn 15 x 120 mm boards
- assembly without tools



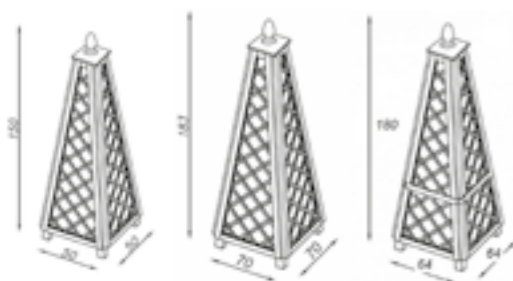

OBELISK WITH FINIAL

- obelisk is a unique feature and excellent support for climbing plants
- available in 3 sizes in durable, natural larch or treated pine
- four English trellises with base and finial
- flat packed, optional cardboard packaging
- easy to assemble

Larch

021767	140 x 50 x 50	
021770	175 x 70 x 70	Premium*
021769	180 x 65 x 65	

Pine

021766	150 x 50 x 50
021765	183 x 70 x 70

*side panels ready assembled, non dhl parcel shippable



WOODEN BRIDGE

- robust, durable garden bridge with side railings
- partially pre-assembled for easy installation
- Bespoke product – lengths available up to 13 m

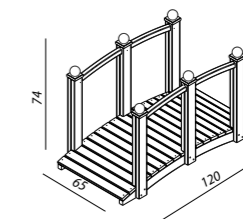

050907 74 x 120 x 65

LOG STORE

- solid construction with 17 x 90 mm boards
- flat packed
- easy to assemble

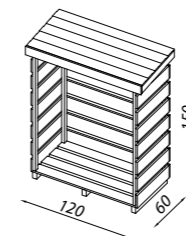

050301 150 x 120 x 60



052067	40 x 75 x 75	163l
052066	80 x 87 x 87	398l
052065	100 x 94 x 94	548l
052064	110 x 96 x 96	625l

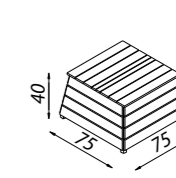
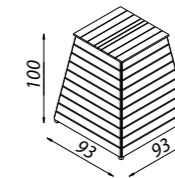
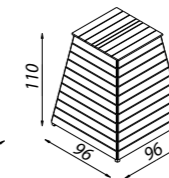
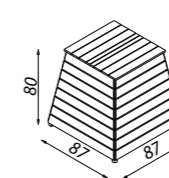

MODULAR COMPOSTER

- odourless - compost rapidly produced
- eco-friendly - made of natural wood
- durable - pressure treated
- modular - grows with your compost

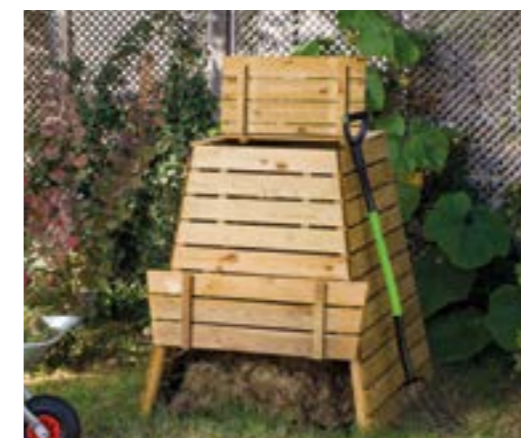

Landscaping Timber

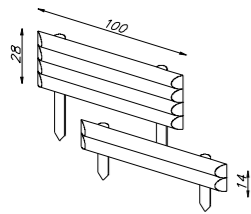

010857 14/28 x 100

ROBIN FENCING

- made of two-sides chamfered half palisades

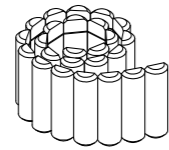

011680 h15 x 180 (6")
011635 h22 x 180 (9")
011636 h30 x 180 (12")

LOG ROLL

- made of one-side chamfered half palisades
- connected by zinc-coated wire

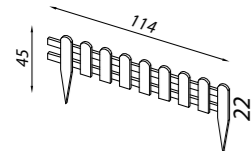

025640 22 x 114

MINI PICKET FENCE

- made with 10 boards: 16 x 65 mm,
- grooved, rounded tops

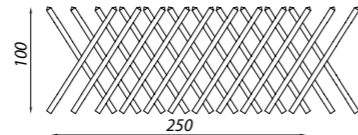

024613 100 x 250

CROSS FENCE



025613 100 x 100

CROSS FENCE GATE

- made of halfround logs
- chamfered ends
- connected by zinc-coated nails

Outdoor Lamps

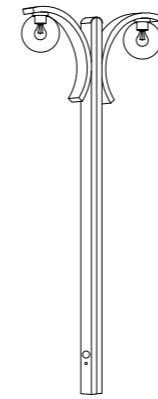

Garden lamps in beautiful, classic and timeless design. Made of highest quality, laminated and pressure treated wood.

LAMP WITH 2 ARCHES

0102112 H 200

LAMP WITH 2 ARCHES (ASYMMETRIC)

- durable plastic shade and inox post cover
- ready for electric installation
- easy to assemble

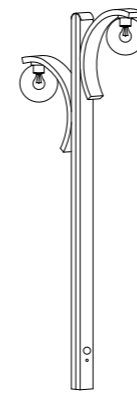

0102113 H 42

SCENCE

- durable plastic shade
- ready for electric installation
- easy to assemble



0102110 H 80
0102108 H 120

LAMP WITH ARCH

- durable plastic shade and inox post cover
- ready for electric installation
- easy to assemble

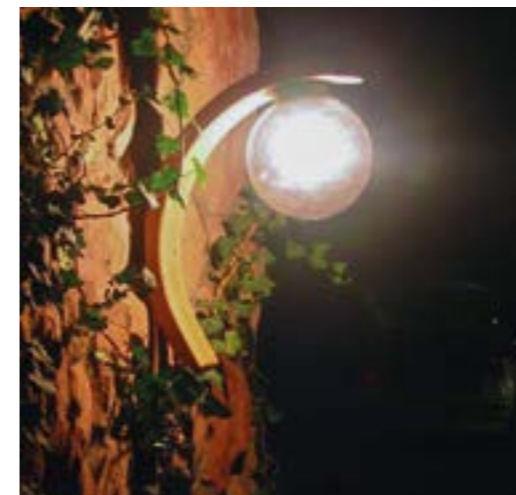

Wooden Garden Trellises

a wooden trellis is an ideal surface for plants to climb on and it makes for a perfect partition to create an intimate space

Garden trellises are perfect for supporting climbing plants, but that's only one of their many advantages. They provide an easy way to alter the look of your garden, terrace or even balcony. Moreover, you can install trellises to isolate the space from neighbours, block and unsightly view or to create an intimate area that makes one feel more at home.

How to choose the best trellis to suit your space? Keep in mind the various densities, as they may be useful for different purposes. For climbing plants, grilles with larger openings are more convenient, but if the trellis is to act as a partition, opt for denser ones. For a more modern feel, choose trellis with horizontal, dense sections between narrow openings, or go with the traditional version with square sections set at different angles. Installing well-chosen trellises can effortlessly make your leisure space more attractive and arrange it to suit your taste.

See our products at
jagramgroup.com
jagram.co.uk



Premier collection

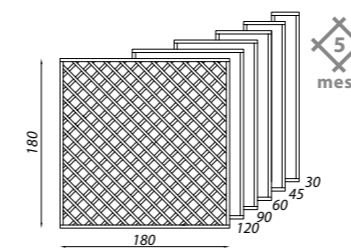

- 021500 180 x 30
- 021501 180 x 45
- 021502 180 x 60
- 021503 180 x 90
- 021505 180 x 120
- 021507 180 x 180

PREMIER TRELLIS

- planed, smooth surface
- frame: 44 x 34 mm, morticed corner joints
- laths: 30 x 9 mm, chamfered edges
- gap size: 50 x 50 mm



Pelargonium geranium

Classic Square collection

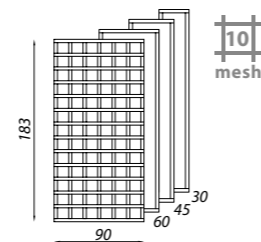

- 021871 183 x 30
- 021872 183 x 45
- 021873 183 x 60
- 021874 183 x 90

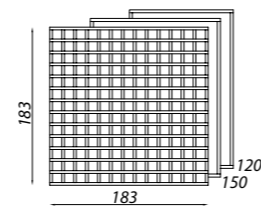

- 021875 183 x 120
- 021876 183 x 150
- 021877 183 x 183

HD CLASSIC SQUARE TRELLIS

- rough sawn, square cut
- laths: 14 x 32 mm
- gap size: 100 x 100 mm

Elegance collection

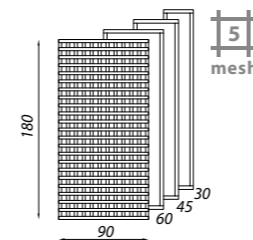

- 021850 180 x 30
- 021851 180 x 45
- 021852 180 x 60
- 021853 180 x 90

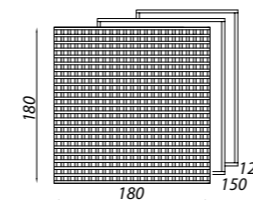

- 021854 180 x 120
- 021856 180 x 150
- 021855 180 x 180

ELEGANCE TRELLIS

- planed, smooth surface
- laths: 30 x 12 mm, chamfered edges,
- gap size: 50 x 50 mm

English collection

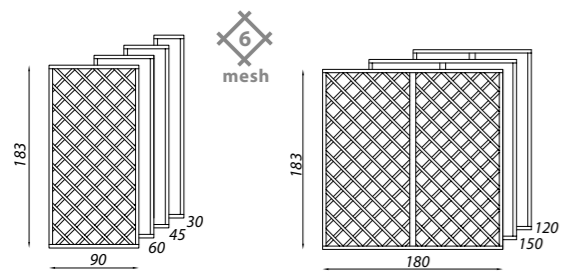

021752	183 x 30	021748	183 x 120
021753	183 x 45	021747	183 x 150
021751	183 x 60	021749	183 x 180
021750	183 x 90		

ENGLISH TRELLIS

- planed, smooth surface
- frame: 30 x 35 mm, morticed corner joints
- laths: 20 x 8 mm, chamfered edges
- gap size: 60 x 60 mm

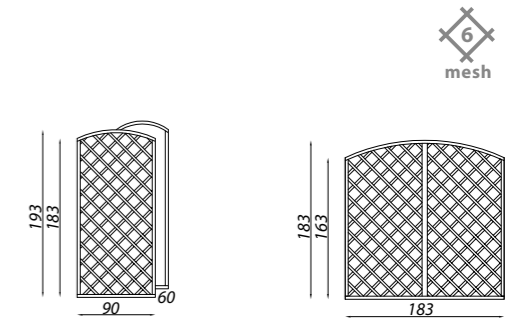

021727	183 / 193 x 60	021778	163 / 183 x 183
021725	183 / 193 x 90		

ENGLISH TRELLIS CONVEX

- planed, smooth surface
- frame: 30 x 35 mm, morticed corner joints
- laths: 20 x 8 mm, chamfered edges
- gap size: 60 x 60 mm

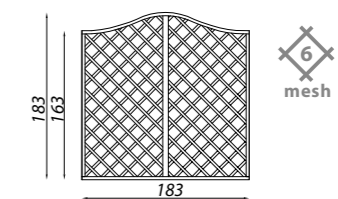

021777	163 / 183 x 183
--------	-----------------

ENGLISH TRELLIS OMEGA

- planed, smooth surface
- frame: 30 x 35 mm, morticed corner joints
- laths: 20 x 8 mm, chamfered edges
- gap size: 60 x 60 mm

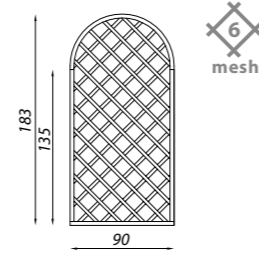

021540 135/183/135 x 90

ENGLISH ROSE TRELLIS

- planed, smooth surface
- frame: 30 x 35 mm, morticed corner joints
- laths: 20 x 8 mm, chamfered edges
- gap size: 60 x 60 mm

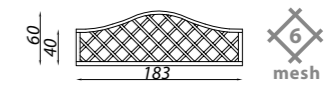

021724 40/60/40 x 183



021723 25/45/25 x 183

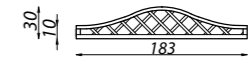

21722 10/30/10 x 183

ENGLISH TRELLIS OMEGA TOP

- planed, smooth surface
- frame: 30 x 35 mm, morticed corner joints
- laths: 20 x 8 mm, chamfered edges
- gap size: 60 x 60 mm

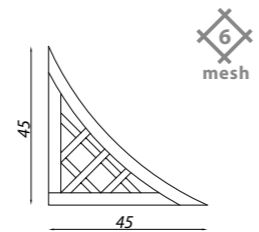

021620 45 x 45

ENGLISH TRELLIS CORNER ELEMENT

- planed, smooth surface
- frame: 30 x 35 mm, morticed corner joints
- laths: 20 x 8 mm, chamfered edges
- gap size: 60 x 60 mm

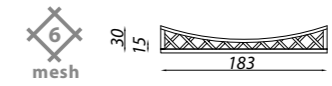

021732 30/15/30 x 183

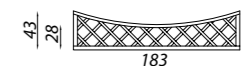

021731 43/28/43 x 183

ENGLISH TRELLIS CONCAVE TOP

- planed, smooth surface
- frame: 30 x 35 mm, morticed corner joints
- laths: 20 x 8 mm, chamfered edges
- gap size: 60 x 60 mm

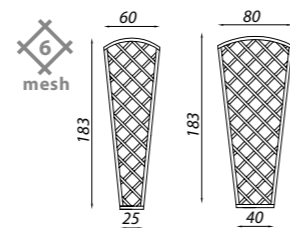

021756 183 x 60

021757 183 x 80

ENGLISH WALL TRELLIS

- planed, smooth surface
- frame: 30 x 35 mm, morticed corner joints
- laths: 20 x 8 mm, chamfered edges
- gap size: 60 x 60 mm

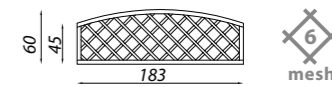

021740 45/60/45 x 183

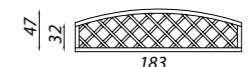

021741 32/47/32 x 183

ENGLISH TRELLIS CONVEX TOP

- planed, smooth surface
- frame: 30 x 35 mm, morticed corner joints
- laths: 20 x 8 mm, chamfered edges
- gap size: 60 x 60 mm

Privacy collection

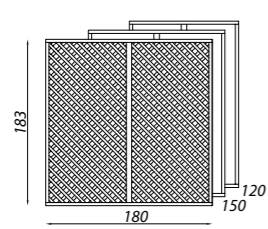
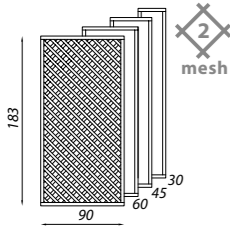

PRIVACY DIAMOND TRELLIS

- planed, smooth surface
- frame: 30 x 35 mm, morticed corner joints
- laths: 20 x 8 mm, chamfered edges
- gap size: 20 x 20 mm



021830	183 x 30	021833	183 x 120
021829	183 x 45	021835	183 x 150
021831	183 x 60	021834	183 x 180
021832	183 x 90		

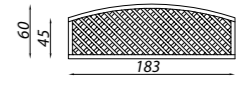

021841 45/60/45 x 183

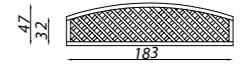

021844 32/47/32 x 183

PRIVACY DIAMOND TRELLIS CONVEX TOP

- planed, smooth surface
- frame: 30 x 35 mm, morticed corner joints
- laths: 20 x 8 mm, chamfered edges
- gap size: 20 x 20 mm

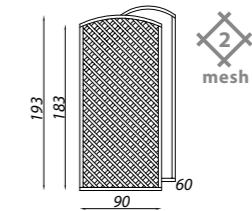

021810 183/193 x 60

021812 183/193 x 90

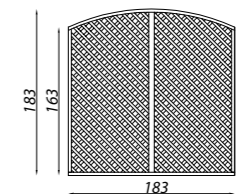

021816 163/183/163 x 183

PRIVACY DIAMOND TRELLIS CONVEX

- planed, smooth surface
- frame: 30 x 35 mm, morticed corner joints
- laths: 20 x 8 mm, chamfered edges
- gap size: 20 x 20 mm

Tartan collection

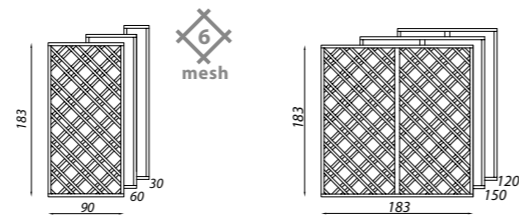
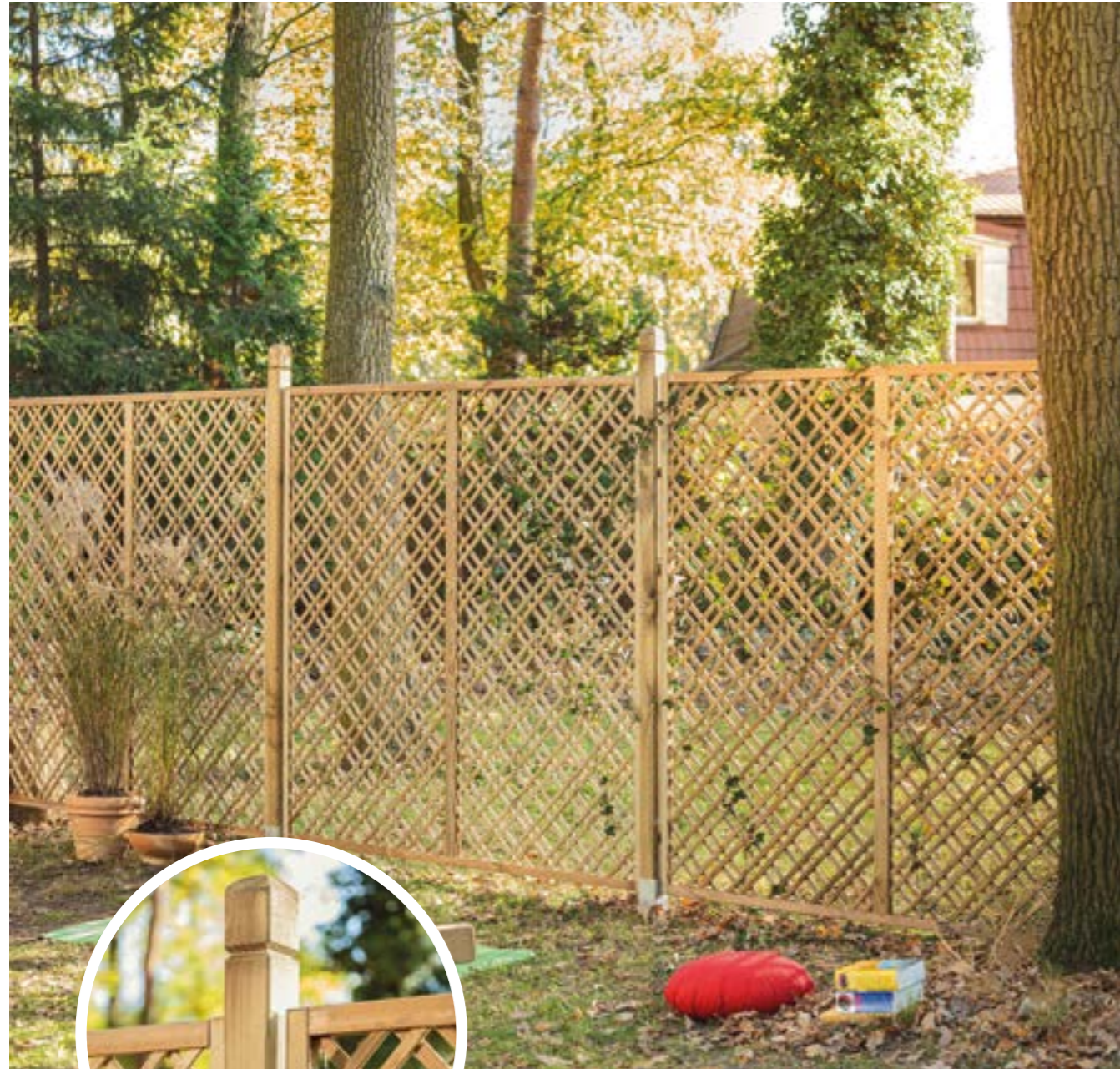

TARTAN TRELLIS

- planed, smooth surface
- frame: 30 x 35 mm, morticed corner joints
- laths: 20 x 8 mm, chamfered edges
- gap size: 60 x 60 mm

023207	183 x 30
023205	183 x 60
023204	183 x 90

023203	183 x 120
023202	183 x 150
023201	183 x 183

Oslo collection

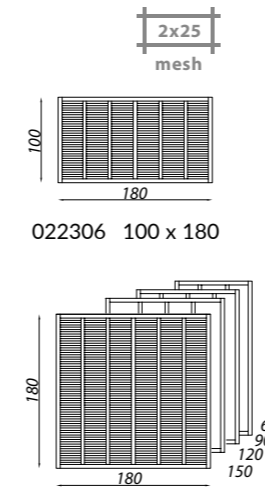

022306 100 x 180

022301	180 x 60
022302	180 x 90
022303	180 x 120
022305	180 x 150
022304	180 x 180

OSLO TRELLIS

- planed, smooth surface
- frame: 44 x 34 mm, morticed corner joints
- laths: 20 x 8 mm, chamfered edges
- gap size 21 mm



Fencing Panels & Gates

Mjosa collection

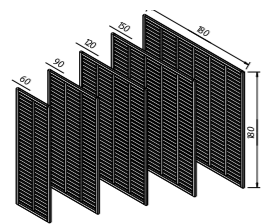

- 021454 180 x 60
- 021453 180 x 90
- 021452 180 x 120
- 021451 180 x 150
- 021450 180 x 180

MJOSA PANEL

- planed, smooth surfaces
- frame: 30 x 40 mm, morticed corner joints
- laths: 40 x 8 mm, chamfered edges
- 19 mm gap size



MJOSA DOUBLE SLATTED

- slats mounted alternately on the front and back of the panel
- frameless - a continuous look
- planed, smooth surfaces
- capping on top of the fence
- laths: 40 x 8 mm, chamfered edges
- 14 mm gap size

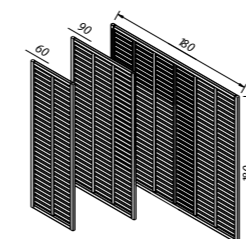

MJOSA DOUBLE SLATTED PANEL TOP

- 021466 30 x 180
- 021467 60 x 180
- 021468 90 x 180
- 021469 120 x 180
- 021470 150 x 180

- 021464 180 x 60
- 021463 180 x 90
- 021460 180 x 180



Larix collection

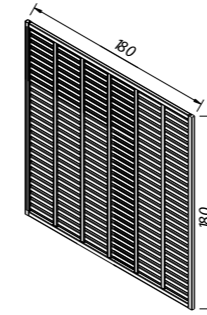

LARIX DOUBLE SLATTED PANEL

- planed, smooth surfaces
- uprights 22 x 50 mm
- laths: 10 x 50 mm in durable, slow grown larch
- 11 mm gap size mm
- Protective capping

021571M 180 x 89
021570M 180 x 180

Elegant contemporary panel ensuring 100% privacy in durable, slow grown larch.

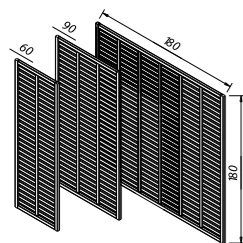

LARIX SLATTED PANEL

- planed, smooth surfaces
- frame: 30 x 40 mm,
- morticed corner joints
- laths: 10 x 50 mm, chamfered edges
- 9 mm gap size mm in durable, slow grown larch

021552M 180 x 60
021551M 180 x 90
021550M 180 x 180

Elegant contemporary panel in smooth finish. Ensures significant privacy and penetration of light. Made of slow grown durable larch



Venetian Shutter Panels collection

Venetian shutter panels provide a practical solution to the age-old dilemma of balancing the desire for seclusion with the appreciation of open spaces. Can both needs be satisfied? Our answer: shield your balcony or garden while still maintaining a glimpse of the outside world. Picture a tranquil balcony overlooking a lively street or a serene garden oasis amidst the chaos of urban life. With Venetian shutter panels, individuals can seamlessly tailor their outdoor spaces to reflect their mood and preferences. For those seeking the flexibility to alternate between solid walls and expansive vistas, we recommend considering the adjustable version.

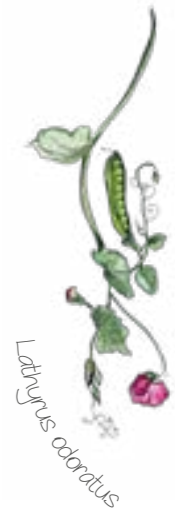

Our Venetian Shutter Panel was designed for that special area in your garden - the shutter opens and closes when you need privacy or shade. Easy operation and treated for a longer life.

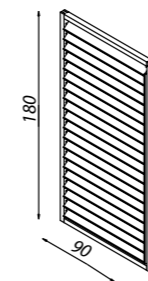

022310 180 x 90

VENETIAN ADJUSTABLE SHUTTER PANEL - PINE

- adjustable slats connected by aluminium rod
- frame: 36 x 42 mm
- smooth, treated pine slats: 10 x 90 mm
- ready assembled

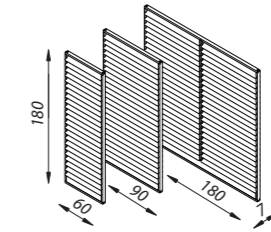

**VENETIAN FIXED SHUTTER
PANEL - LARCH**

- smooth surface
- naturally durable slow-grown larch timber
- frame: 22 x 42 mm
- slats: 10 x 100 mm

022322	60 x 180 x 7
022321	90 x 180 x 7
022320	180 x 180 x 7

Venetian-style louvered panel with fixed, angled slats. This contemporary design panel, made in quality larch timber, offers privacy, airflow and partial light penetration at the same time.

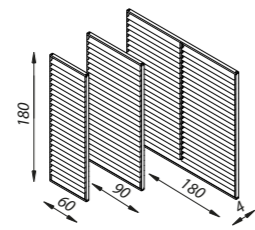

VENETIAN LITE

- smooth surface
- naturally durable slow-grown larch timber
- frame: 22 x 32 mm
- slats: 10 x 49 mm
- ready assembled

022370M	60 x 180 x 4
022371M	90 x 180 x 4
022372M	180 x 180 x 4



European Panels collection

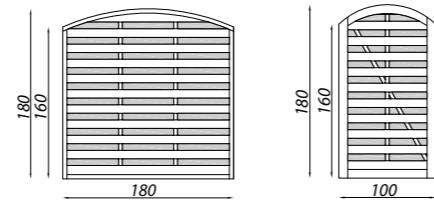

021140 180/160 x 180 021434 180/160 x 100

MALVERN PANEL MALVERN GATE

- planed and chamfered
- frame: 44 x 44 mm
- slats: 8 x 90 mm with grooved finish

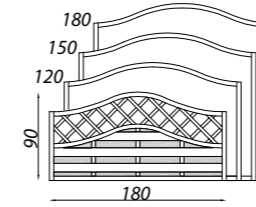

02112670/90 x 180 (3')
 021128100/120 x 180 (4')
 021127130/150 x 180 (5')
 021125160/180 x 180 (6')

SALISBURY PANEL

- planed and chamfered
- frame: 44 x 44 mm
- slats: 8 x 90 mm with grooved finish

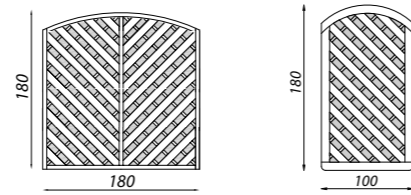

021300160/180 x 180 (6') 021305 160/180 x 100

YORK PANEL YORK GATE

- planed and chamfered
- frame: 45 x 45 mm
- slats: 8 x 95 mm with grooved finish

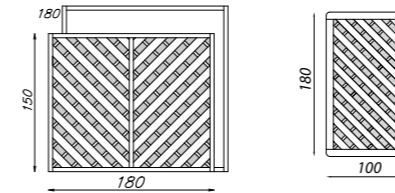

021351150 x 180 (5') 021304 180 x 100
 021220180 x 180 (6')

BEVERLEY PANEL BEVERLEY GATE

- planed and chamfered
- frame: 44 x 44 mm
- slats: 8 x 90 mm width
- grooved finish

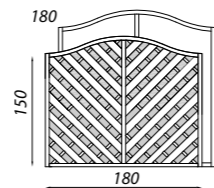

021363130/150 x 180 (5')
 021322160/180 x 180 (6')

CANTERBURY PANEL

- planed and chamfered
- frame: 44 x 44 mm
- slats: 8 x 90 mm with grooved finish

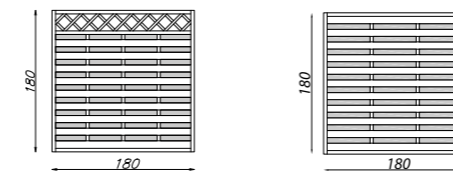

021427 180 x 180 021425 180 x 180

HAMBURG PANEL RIPON PANEL

- planed and chamfered
- frame: 44 x 44 mm
- slats: 8 x 90 mm with grooved finish

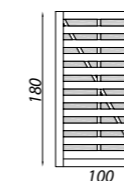

021433 180 x 100

RIPON GATE



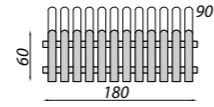

025630 60 x 180

025635 90 x 180

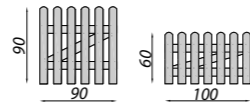

025698 90 x 90

025696 60 x 100

BOARD FENCE & GATE

- boards: 16 x 90 mm
- round top with chamfered edges

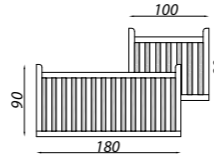

021175 90 x 100

021171 90 x 180

WINDSOR FENCE AND GATE

- planed and chamfered
- frame: 44 x 68 mm
- slats: 16 x 70 mm

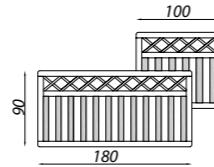

021174 90 x 100

021170 90 x 180

CHATSWORTH FENCE AND GATE

- planed and chamfered edges
- frame: 44 x 68 mm
- slats: 16 x 90 mm
- laths: 30 x 12 mm

Accessories

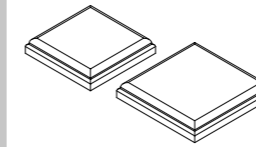

060101 10 x 10

060102 12 x 12

POST CAP

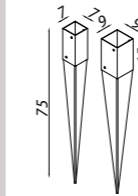

051910 75 x 7 x 7

051911 75 x 9 x 9

METAL POST HOLDER

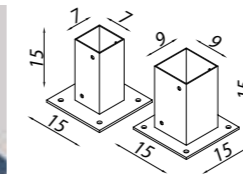

051931 15 x 7 x 7

051930 15 x 9 x 9

METAL POST HOLDER FOR CONCRETE

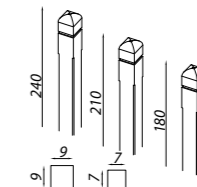

014117 180 x 7 x 7

014118 210 x 7 x 7

014125 240 x 7 x 7

014128 240 x 9 x 9

FENCE POST

014002 180 x 7 x 7

014003 210 x 7 x 7

014004 240 x 7 x 7

FENCE POST

-LUXDIAMOND TOP

014013 210 x 9 x 9

014014 240 x 9 x 9

014019 300 x 9 x 9

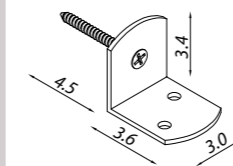

051920

L-BRACKET

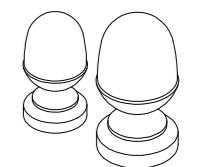

064201 Ø 6.8

064211 Ø 9.6

ACORN

Garden Arbours

A bench is essential in every garden, offering a place to sit and unwind. A bench where you can not only sit for a while, but also settle down comfortably and isolate yourself from your surroundings is a true luxury. Jagram arbours guarantee such conditions - made of solid wood, beautifully designed, comfortable to sit on, and providing privacy. What better place for a romantic chat, a moment's respite away from loved ones, or a gossip with a friend?

And if you choose the Finley Arbour – our newest addition – you can transform any nook of your garden while enjoying complete shelter from the sun and wind. The contoured, conveniently accessible bench box provides additional storage space and ensures supreme comfort.

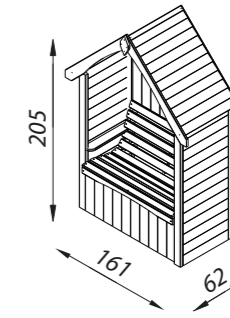

040187 161 x 62 x 205

FINLEY ARBOUR

- full back and side panels, offering shelter from the sun and wind
- conveniently accessible bench box provides additional storage space
- comfortable, wide, contoured bench with armrests
- flat packed



ROCCOLO LITE ARBOUR

- eye-catching arched roof of sturdy laminated construction
- open sides allow for a wide view
- comfortable, wide, contoured bench with armrests
- strong, fully framed back and side panels in a modern, slatted style
- flat packed

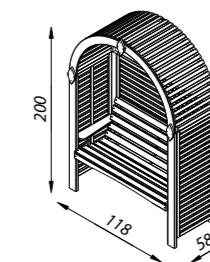

040206 118 x 58 x 200

ROCCOLO LITE FULL SIDED

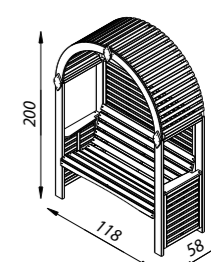

040206 118 x 58 x 200

ROCCOLO LITE OPEN VIEW

Contemporary collection

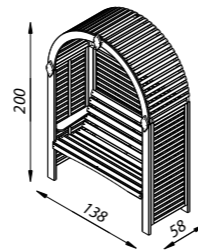

040202 138 x 58 x 200
ROCCOLO
FULL SIDED

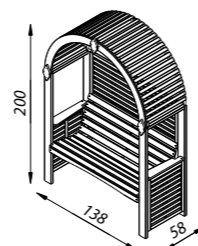

040203 138 x 58 x 200
ROCCOLO
OPEN VIEW

ROCCOLO ARBOUR

- eye-catching arched roof of sturdy laminated construction
- open sides allow for a wide view
- comfortable, wide, contoured bench with armrests
- strong, fully framed back and side panels in a modern, slatted style
- flat packed

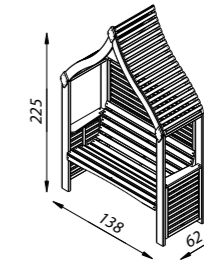

040205 138 x 62 x 225
SIENA OPEN VIEW

SIENA ARBOUR

- slatted roof in Eastern style
- open sides allow for a wide view
- comfortable, 120 cm wide, contoured bench with armrests
- strong, fully framed rear and side panels in a modern, slatted style
- easy assembly
- excellent quality European pressure treated wood
- 10-year manufacturer's warranty*
- flat packed

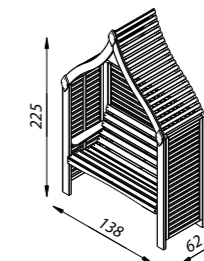

040204 138 x 62 x 225
SIENA FULL SIDED





The excellent quality contemporary gazebo collection has clean, simple lines and an attractive, modern design. You can comfortably enjoy the look of the garden with open sides and large armrests in the open-view version, or just feel cosy in the full-sided version. Both versions feature contoured benches with a width of 120 cm.

ORIO ARBOUR

- a full gable roof protecting against the sun and rain
- open sides allow for a wide view
- comfortable, 120 cm wide, contoured bench with armrests
- strong, fully framed rear and side panels in a modern, slatted style
- flat packed



Classical collection

ROMANTICA ARBOUR

- comfortable armrests,
- arched roof, ideal for climbing plants
- flat packed

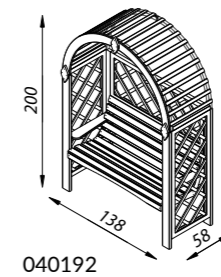

040192



The Romantica Arbour is a wonderful seating area that offers shelter and shade. The Venetian style roof and trellis side and back panels enable you to train plants to climb up and around this beautiful wooden arbour that has been designed to last.

OXFORD ARBOUR

- comfortable armrests
- a full, gable roof protecting against the sun
- a new ergonomic bench
- flat packed

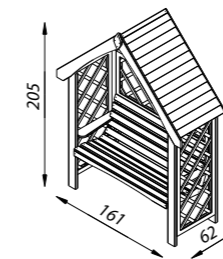

040186

SIAM ARBOUR

- comfortable armrests
- comfortable, ergonomic bench
- arched roof, ideal for climbing plants
- flat packed

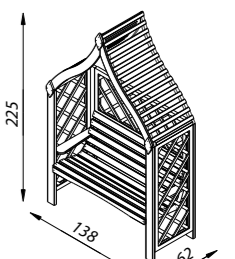

040190

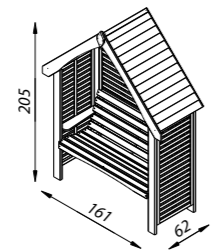

040200

ORIO FULL SIDED

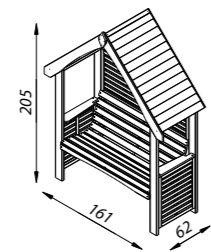

040201

ORIO OPEN VIEW





MILTON CORNER ARBOUR

- posts: 70 x 70 mm
- trellis gap size: 60 x 60 mm
- trellis laths: 20 x 8 mm
- two ergonomic seatings
- useful table between benches
- flat packed
- easy to assemble

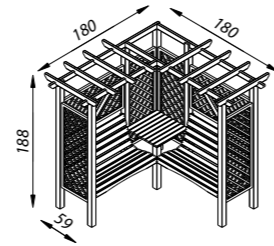

040184



HENLEY ARBOUR

- excellent support for climbing plants
- classic design - suits gardens of any style
- easy to complement with accessories such as trellis, roof mats, polycarbonate canopy
- easy to install with pre-cut and pre-drilled components

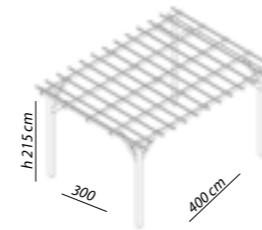

- 041853 215 x 300 x 300
- 041907 215 x 300 x 400
- 041908 215 x 300 x 600
- 041910 215 x 400 x 400
- 041913 215 x 400 x 600

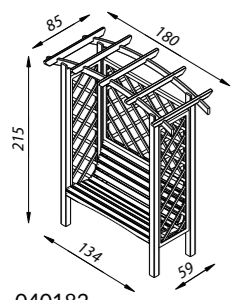

LINTON ARBOUR

- post: 70 x 70 mm
- trellis gap size: 120 x 120 mm
- trellis lath: 30 x 10 mm
- ergonomic seating
- flat packed
- easy to assemble

040182

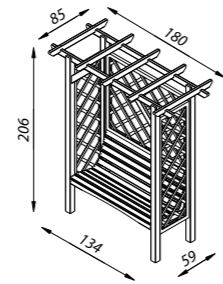

YORK ARBOUR

- posts: 70 x 70 mm
- trellis gap size: 120 x 120 mm
- trellis lath: 30 x 10 mm
- ergonomic seating
- flat packed
- easy to assemble

040181

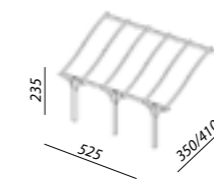

S-line size: 3.5 / 4.1

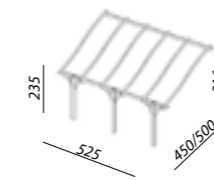

S-line size: 4.5 / 5.0

- 041858 size 5.0 316/235 x 500 x 525
- 041852 size 4.5 316/235 x 450 x 525
- 041850 size 4.1 316/235 x 410 x 525
- 041851 size 3.5 307/235 x 350 x 525

S-LINE ARBOUR (LEAN-TO) *

- posts: 120 x 120 mm
- roof made of laminated curves
- excellent support for climbing plants or comfortable shading for a patio
- variety of applications with optional accessories (pergola with canvas roof shading, veranda with solid roof)

* Solid roof cover and painting brown colour not included

Garden Arches



MOONGATE

- attractive garden focal point
- can be used as an arch over a pathway or as a wedding arch
- durable, tanalised, multi-layer laminated wood
- 10-year Jagram guarantee against rot*

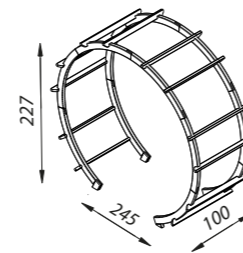
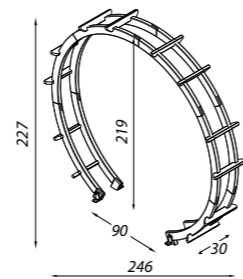

041060 246 x 30 x 227

041063 245 x 100 x 227

The wooden arch is indeed quite an eye-catcher. Regardless of your taste - whether modern or traditional, we have it all at Jagrams. Once placed at the entrance to your garden or over a pathway, it becomes the focal point. Those crafted by Jagram are sturdy and capable of bearing the weight of robust climbing plants, winding vines, and even bountiful fruits. Adorned with cascading blooms, they often serve as enchanting wedding arches..

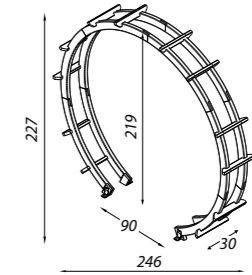

041062 246 x 30 x 227

MOONGATE LED

- attractive garden focal point
- can be used as an arch over a pathway or as a wedding arch
- durable, tanalised, multi-layer laminated wood
- 10-year Jagram guarantee against rot*
- illuminated with an LED strip

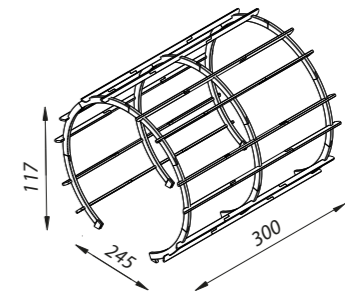

041061 245 x 300 x 117

MOONGATE WALKWAY

- tunnel made of curved laminated arches
- can be used as an arch over a pathway or as a wedding arch
- durable, tanalised, multi-layer laminated wood
- 10-year Jagram guarantee against rot*

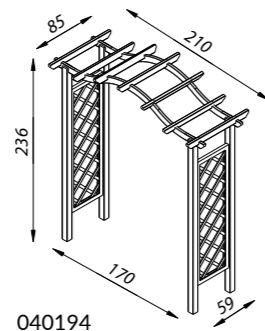

040194

DOVER ARCH

- posts: 70 x 70 mm
- trellis gap size: 120 x 120 mm
- trellis lath: 30 x 10 mm

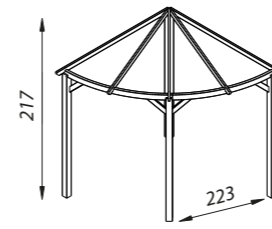

041048 223 x 217

CORNER CIRCLE PERGOLA

Make the most of your backyard corner space with our Corner Pergola. Easily personalize it with a few chairs, a table and flowers of your choice and transform any space into a delightful afternoon tea spot.

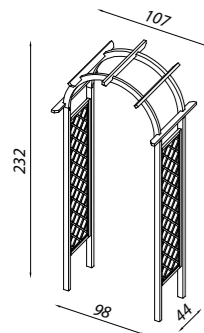
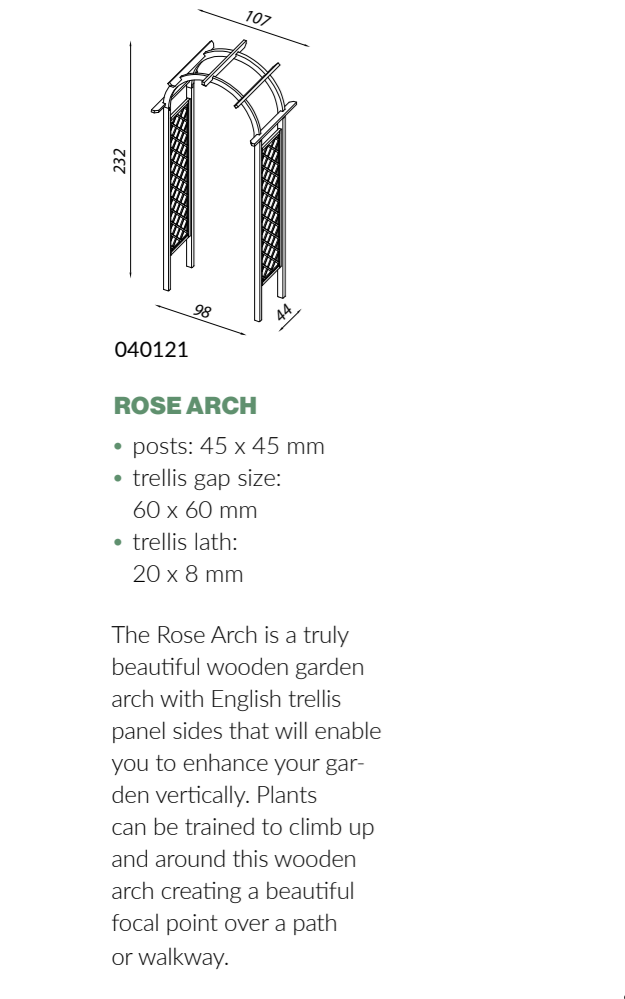

040121

ROSE ARCH

- posts: 45 x 45 mm
- trellis gap size: 60 x 60 mm
- trellis lath: 20 x 8 mm

The Rose Arch is a truly beautiful wooden garden arch with English trellis panel sides that will enable you to enhance your garden vertically. Plants can be trained to climb up and around this wooden arch creating a beautiful focal point over a path or walkway.

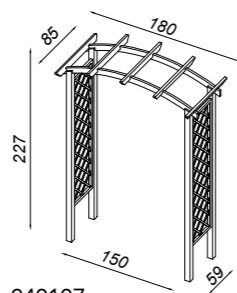

040107

ARCADE ARCH

- posts: 70 x 70 mm
- trellis gap size: 120 x 120 mm
- trellis lath: 30 x 10 mm

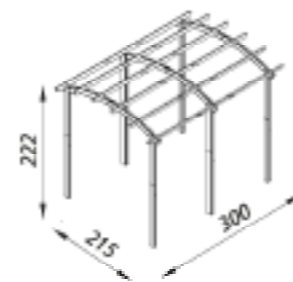
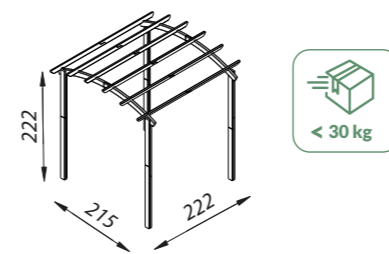

041955 4 posts 215 x 222 x 222
041956 6 posts 215 x 300 x 222

HENLEY WALKWAY

- walkway pergola with curved laminated arches
- side panels as an accessory
- posts: 60 x 90 mm

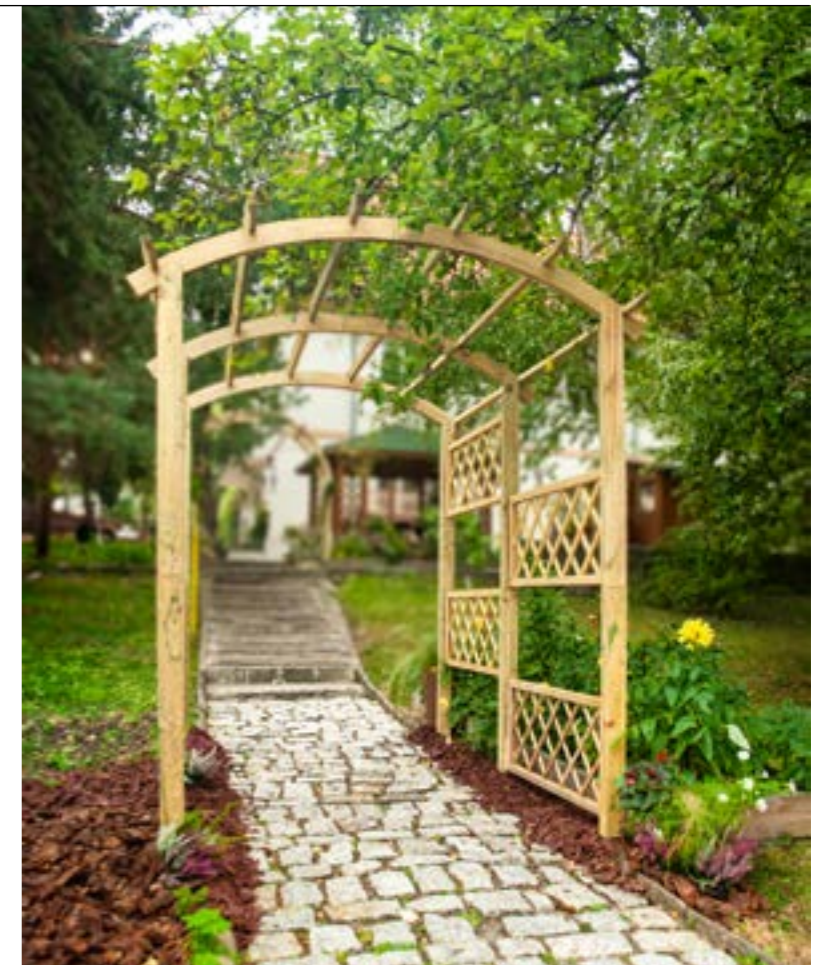

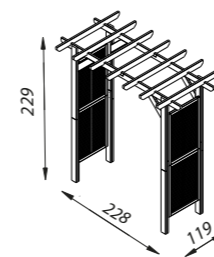

041951 228 x 119 x 229

**HENLEY ARCH
CONTEMPORARY**

- posts: 60 x 90 mm
- trellis gap size: 23 mm
- trellis lath: 8 x 20 mm

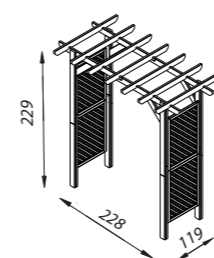

041950 228 x 119 x 229

**HENLEY ARCH
CLASSIC**

- posts: 60 x 90 mm
- trellis gap size: 50 x 50 mm
- trellis lath: 9 x 30 mm

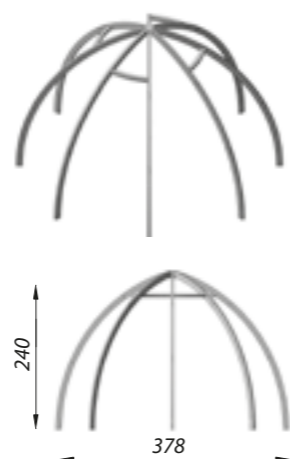

041052 240 x 378
PERGOLA LUNA



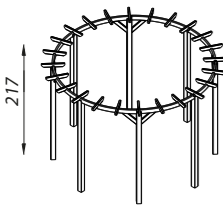

041042 fi480 h220
**PERGOLA CIRCLE
Ø480 SHORT
RAFTERS**

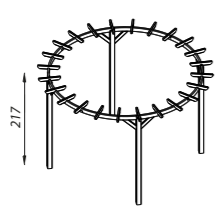

041043 fi300 h220
**PERGOLA CIRCLE
Ø300 SHORT
RAFTERS**

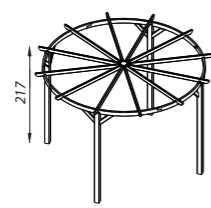

041044 fi300 h220
**PERGOLA CIRCLE
Ø300 LONG
RAFTERS**

Pergola Circle is designed to enhance charm of your gathering space. Create a fairy tale like ambiance to romanticize your evening meals. Personalize it by adding curtains or allowing plants grow forming a natural shelter from the scorching summer heat.

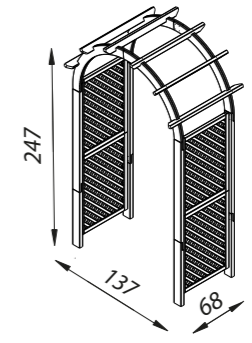

040125 247 x 68 x 137

**PERGOLA ROSE
CLASSIC**

- posts: 40 x 90 mm
- trellis gap size: 50 x 50 mm
- trellis lath: 9 x 30 mm



Choice of 3 types of side panels

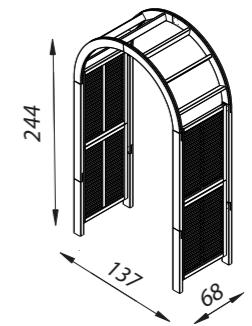

040126 244 x 68 x 137

**PERGOLA ROSE
CONTEMPORARY**

- posts: 40 x 90 mm
- trellis gap size: 21/23 mm
- trellis lath: 8 x 20 mm/
8 x 35 mm



Pavilions



RIMINI TILED

- C41500 310 x 300 x 300
- C41510 310 x 300 x 400
- C41505 310 x 400 x 400

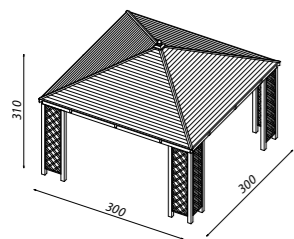

RIMINI

- 041500 310 x 300 x 300
- 041510 310 x 300 x 400
- 041505 310 x 400 x 400

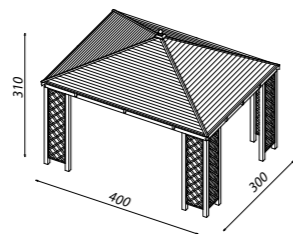

RIMINI

- roof tiles available in either black or green.
- floor sold as an option.
- oslo trellis panels available as an option

The tiled Rimini Entertaining Gazebo features a heavy-duty, handmade diamond trellis, providing an airy spacious area in which to relax with friends and family. This large outdoor entertaining space will easily accommodate a large table and chairs or fit nicely above a hot tub area.



NAPOLI

- modern minimalistic design
- solid pressure treated timber frame
- heavy-duty waterproof canvas.

- 041500 310 x 300 x 300
- 041510 310 x 300 x 400

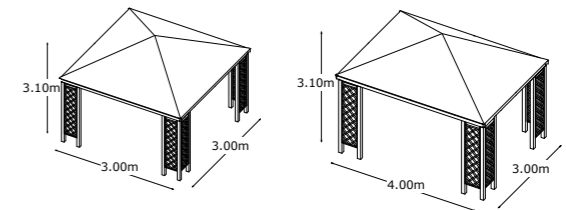

An attractive gazebo with a modern minimalist design. Lightweight but sturdy and stable structure that can be easily moved when needed. Climbing plants will grow quickly on the corner trellis, creating a fabulous effect.





DEAR CUSTOMERS,

JAGRAM IS A COMPANY WITH MORE THAN 30 YEARS OF PROFESSIONAL EXPERIENCE. DURING THESE YEARS WE HAVE SUPPLIED WOOD PRODUCTS OF THE HIGHEST QUALITY TO HUNDREDS OF GARDEN CENTRES, GARDEN BUILDING DISPLAY CENTRES, TIMBER MERCHANTS, RETAILERS AND DISTRIBUTORS. WE WOULD LIKE TO THANK YOU FOR YOUR CONTINUED TRUST AND SUPPORT OVER THE YEARS. WE ARE GRATEFUL FOR CHOOSING JAGRAM. WE WILL CONTINUE TO STRIVE FOR EXCELLENCE AND SERVE YOU TO THE BEST OF OUR ABILITY.



THE JAGRAM TEAM



Certificates

Jagram pays great attention to effective quality management and its compliance with the requirements of the European Union, both in terms of high quality of wood from which our products are made as well as environmentally conscious production system. Our wood comes from ecological European forests and our products can be certified according to the FSC (Forest Stewardship Council®) or PEFC principles on responsible forest management. Our factory has been awarded the ISO 9001 certification which ensures the highest quality of services. Joining the certification program is expensive and requires a lot of effort from Jagram, but it undoubtedly gives us and our customers many benefits:

- facilitates an increase in the level of customer service,
- streamlines management, resulting in lower costs and better prices,
- positively affects the perception of the Jagram brand,
- sets a standard for the competition to source the wood sustainably.

To learn more about the production quality, visit:

jagramgroup.com



The symbol informs that the product can be shipped in a cardboard box and that the dimensions and weight of this box allow using the most advantageous services of global carriers. The product is designed to weigh no more than 30kg and the parcel dimensions are limited to a maximum of 120x60x60cm. However certain products, due to their large dimensions, may require packaging in two or more of these boxes. For further information, please ask our sales team..

* The guarantee applies only for products that do not have direct contact between the wood and the humidity surface. Posts should be isolated from the ground, for example with an anchor.





info@jagram.co.uk
www.jagram.co.uk
www.jagramcatalogue.co.uk
www.jagramgroup.com

